

LED ROUND HIGH BAY

FIELD SELECTABLE | 120V-347V



**FIELD SELECTABLE
(CCT AND WATTAGE)**

RANGE VOLTAGE 120V-347V

INTEGRATED SENSOR PORT

EM BATTERY BACKUP CAPABLE

**6' SUPPLY AND LOW
VOLTAGE WHIPS**

0-10V DIMMING

**BLACK & WHITE FINISHES
AVAILABLE**

SUGGESTED APPLICATIONS

Commercial, Retail,
Warehouses, Manufacturing
Facilities



SATCO|NUVO's Round High Bay Field Selectable fixtures offer an energy-efficient and low-maintenance alternative to traditional HID fixtures. These luminaires are field selectable, giving users the flexibility to choose from three wattage and three CCT options during installation. The fixtures are constructed with a durable die-cast aluminum housing and an IK08 impact-rated polycarbonate lens. Featuring 6kV surge protection, 120V-347V range voltage and NEMA 4X (IP65) wet location rating, these high bays are resilient in various commercial environments. Compatible with a wide variety of accessories (sold separately) fixtures can be customized to accommodate a multitude of lighting needs.



GENERAL SPECIFICATIONS

Range Voltage: 120V-347V
Frequency: 50/60Hz
Power Factor, THD: 0.9, 15%
Dimming: 0-10V dimmable down to 10%
Surge Protection Rating: 6kV
CCT Selectable: 3000K/4000K/5000K
CRI: 80
Functional Life: 50,000 Hours
Beam Angle: 90°

Location Rating: Wet
IP Rating: NEMA 4X (IP65)
Ambient Operating Temperature: -40°C (-40°F) to +50°C (+122°F)
Emergency Backup Compatible: Yes, Accessory Sold Separately
Construction: Die-cast Aluminum with Polycarbonate Lens
Accessories Included: Locking Hanging Hook
Power Cord: 6' Whip



ITEM SPECIFICATIONS / ORDER INFO

Item	Finish	Lumen Range	Wattage	Replacement HID Wattage	Efficacy	DLC ID
65-770R3	Black	11840-18600	80W/100W/120W	150W-250W	Up to 155 LPW	S-3M8BV2
65-771R3	Black	22200-28800	150W/175W/200W	400W-450W	Up to 148 LPW	S-PQ3SZK
65-812	White	11840-18600	80W/100W/120W	150W-250W	Up to 155 LPW	S-3M8BV2
65-813	White	22200-28800	150W/175W/200W	400W-450W	Up to 148 LPW	S-PQ3SZK

DIMENSIONS/WEIGHTS

Item	Diameter (A)	Height (B)	Weight
65-770R3	11.00"	7.30"	4.53 Lbs.
65-771R3	13.40"	7.30"	6.42 Lbs.
65-812	11.00"	7.30"	4.53 Lbs.
65-813	13.40"	7.30"	6.42 Lbs.

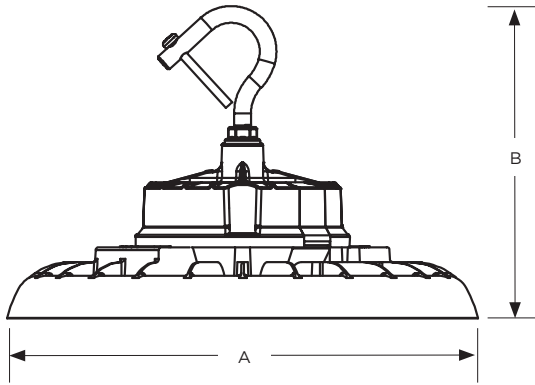

65-770R3/ 65-812

Recommended Up to 20' Mounting Height

80/100/120W

150-250W
HID Replacement

11,840-18,600 Lumens

Up to 155 LPW

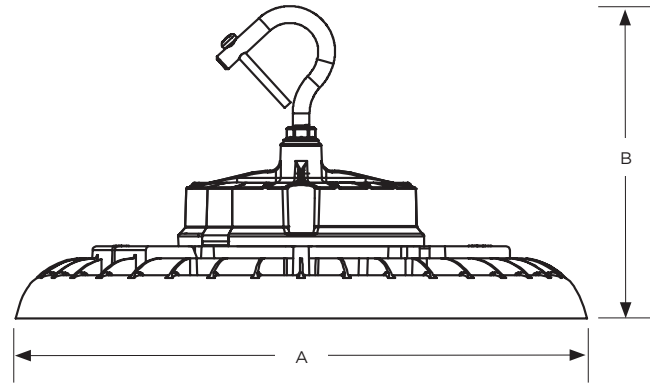

65-771R3/ 65-813

Recommended Up to 30' Mounting Height

150/175/200W

400-450W
HID Replacement

22,200-28,800 Lumens













Up to 148 LPW

This device complies with Part 15 of the FCC Rules. Operation is subject to the following two conditions: (1) this device may not cause harmful interference, and (2) this device must accept any interference received, including interference that may cause undesired operation.







Warning: This product can expose you to chemicals including lead, which is known to the State of California to cause cancer and birth defects or other reproductive harm. For more information go to www.P65Warnings.ca.gov.

Fixture may not be compatible with all dimmers.
 Replacement wattage shown depends on application and fixture.
 Specifications are subject to change without prior notice.

OPTIONAL ACCESSORIES

Item	Description	For Use With	
EM's & Extension Whips			
65-169	IP68 CONNECTOR WITH 5.5FT WHIP LINE SUPPLY - BK	65-770R3, 65-771R3	
65-199	IP68 CONNECTOR WITH 5.5FT WHIP 0-10V SUPPLY - BK	65-770R3, 65-771R3	
65-170	IP68 CONNECTOR WITH 5.5FT WHIP LINE SUPPLY - WH	65-812, 65-813	
65-200	IP68 CONNECTOR WITH 5.5FT WHIP 0-10V SUPPLY - WH	65-812, 65-813	
65-780	30W ADD ON EM UFO HIGH BAYS	65-770R3, 65-812	
65-815	40W ADD ON EM UFO HIGH BAYS	65-771R3, 65-813	
Yoke Mounts & Pendant Adaptors			
65-765	YOKE MOUNT FOR UFO - BK	65-770R3	
65-763	YOKE MOUNT FOR UFO - WH	65-812	
65-766	YOKE MOUNT FOR UFO - BK	65-771R3	
65-764	YOKE MOUNT FOR UFO - WH	65-813	
65-769	3/8" TO 3/4" PENDANT ADAPTER - BK	65-770R3, 65-771R3	
65-759	3/8" TO 3/4" PENDANT ADAPTER - WH	65-812, 65-813	

OPTIONAL ACCESSORIES

Item	Description	For Use With	
Diffusers, Reflectors & Wire Guards			
65-778	ADD ON REFLECTOR	65-770R3, 65-812	
65-779	ADD ON REFLECTOR	65-771R3, 65-813	
65-811	ADD ON PC SHADE	65-770R3, 65-812	
65-799	ADD ON PC SHADE	65-771R3, 65-813	
65-790	ADD ON BOTTOM DIFFUSER USE WITH 65-811	65-770R3, 65-812	
65-800	ADD ON BOTTOM DIFFUSER USE WITH 65-799	65-771R3, 65-813	
65-809	PROTECTIVE WIRE GUARD	65-770R3, 65-812	
65-810	PROTECTIVE WIRE GUARD	65-771R3, 65-813	
Sensors			
86-220	ADD ON PIR SENSOR/12 METER	ALL	
86-217	ADD ON PIR SENSOR/6 METER	ALL	
86-218	ADD ON MICROWAVE SENSOR	ALL	
86-219	REMOTE FOR ADD ON SENSORS	ALL	

When combining the EM option with the sensor option, the infinity setting must be used. The fixture can bi-level dim but not shut off completely.